

Drainway

STORMWATER INLET SYSTEM

DESIGN CAPTURE CHARTS

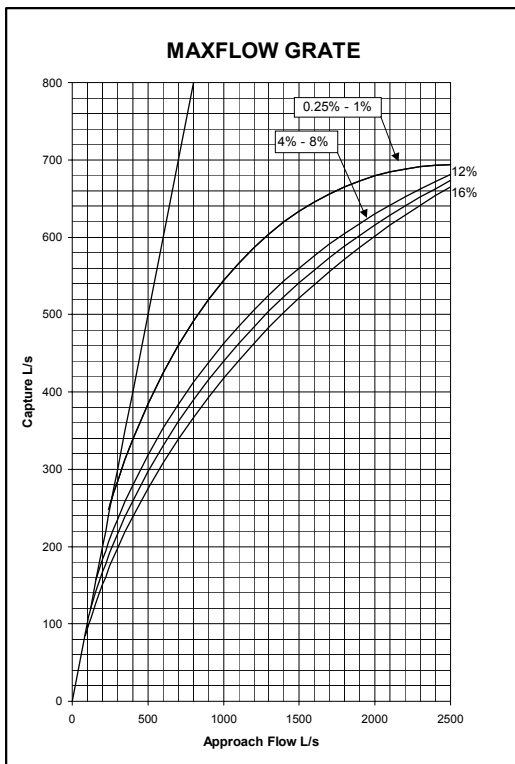
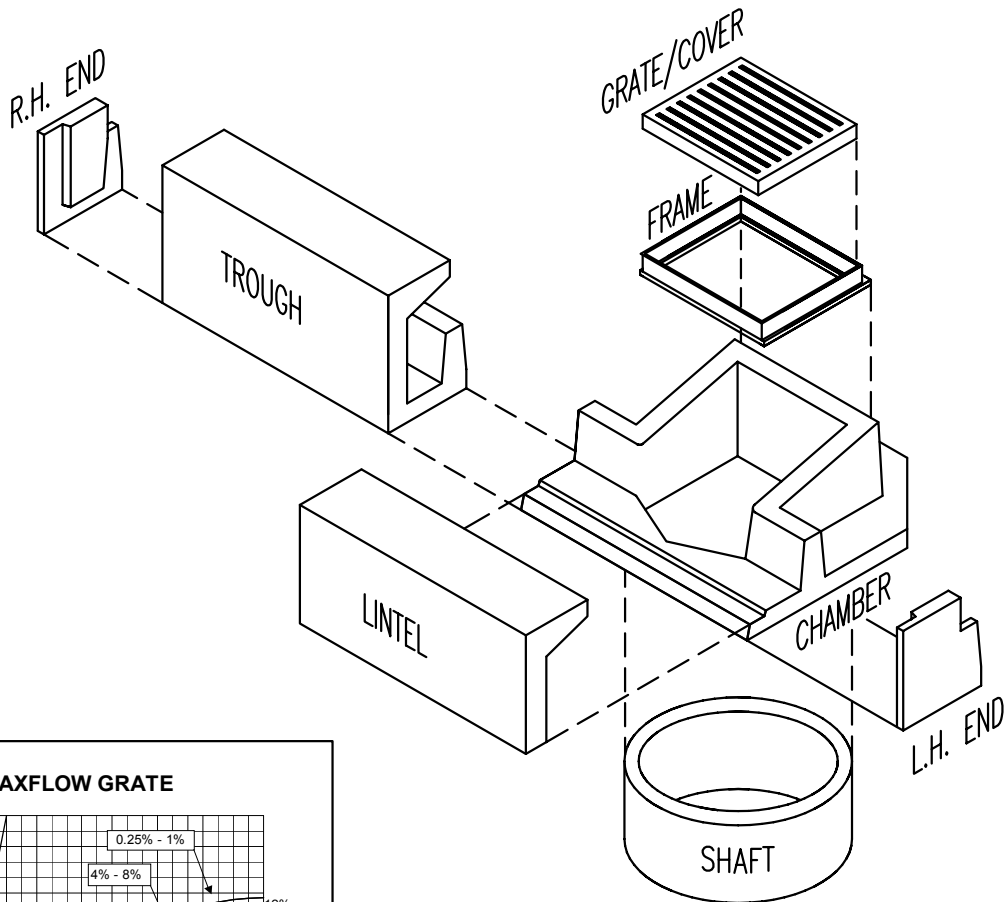

Max Q

CONTENTS

DRAINWAY

Introduction	Page 2
Precast Units	Page 3
Maxflow Grate	Page 4
Mannflow Grate	Page 6
Draincover	Page 8
Sag Capture	Page 10
Conversion Factors	Page 11
Inlet Design Drawing	Page 12

Drainway, described in this manual, is a high quality stormwater inlet system using precast concrete kerb inlet units and a chamber that may be mounted directly over a precast or cast in situ circular manhole. In this package, design options include two high quality grates and a cover combined with four alternative kerb inlet lengths.

Stormway, described in a separate manual, is based on cast in situ gully pits or rectangular inlet manholes. The package design options again include two high quality grates and a cover, these being combined with five alternative kerb inlet lintel lengths.

Inlets from both systems may be combined in the same stormwater drainage network using the more economical Stormway gully pits on line ends with Drainway inlets providing the trunk line manholes. The grates and covers in both systems are complementary.

The inlet capacity charts provided for both systems cover approach flows to 2500L/s (up from 500 L/s) permitting designers to take full advantage of the Qudm allowable roadway flows. Design capture properties for both inlet systems have been incorporated into most recognised stormwater drainage design programs.

Drainway and Stormway are lip-in-line inlets.

DRAINWAY PLUS

STORMWATER INLET SYSTEM

Introduction

Drainway is a superior and widely used stormwater system. Its advantages include:

1. High quality precast concrete components.
2. Uniform and close construction tolerances.
3. Combination of inlet and manhole.
4. The structural superiority of circular pits.

Drainway Plus has the following further advantages:

1. Design chart range extended from 500L/s to 2500L/s.
2. Extra capture capacity is achieved by incorporation of a deflector on the lintel.
3. Kerb openings are reduced to a child safe desirable maximum of 100mm.
4. Design charts for Mannflow and Maxflow grates, replace those for the discontinued Hydraflow.

Lintels with the deflector are now readily available as are the new grates Mannflow and Maxflow. These grates as well as a cover have been flow calibrated with the deflector in place using 100mm kerb opening. The calibration flow range is 1800L/s with curves extrapolated to 2500L/s by the test authority. The modified design is designated *Drainway Plus* to distinguish it from *Drainway*. The inlet capacity charts in this package are based on model testing which incorporates the innovations listed.

Flow Deflector

The flow deflector referred to above is that described in the IMEAQ Conference Papers 1996, Paper 22 by Chris Lawson.

Hydraulic Modelling

Hydraulic modelling was carried out at half scale using the apparatus described in the above paper. Half scale results are, for all practical purposes, identical to results at full scale.

Base modelling on grade was carried out at 3% crossfall with mountable kerb. Separate tests for crossfalls from 2% to 4% and barrier kerb with 300mm and 450mm channel permit calculation of factors for conversion to the other configurations.

Sag inlets tests were conducted with the cover only. Measured sag captures therefore ignore inflow through a grate.

Precast Units

Drainway Plus units are identical to the original design, set out in IPWEA Dwg D-0064, apart from the lintel with deflector shown in Dwg D1 in this package.

Inlets are made up of a base chamber and 1350 lintel which may be extended by up to 3 x 1350 troughs.

Inlet Codes

Drainway Plus codes are distinguished from the original *Drainway* by using 'P' in lieu of 'C' to denote the lintel and chamber. 'T' denotes a trough. The four inlets are:

Code	0TP	1TP	2TP	3TP
Troughs	0	1	2	3

Construction Details

Construction details for *Drainway Plus* inlets are shown in Dwg D1. Kerb transition lengths are 700mm minimum with the upstream transition on grade increased incrementally from 700mm for 0TP to 2000mm for 3PT inlets. Longer transitions increase capture on grade. It should be noted, that for ease in setting out, the distance to the centreline of the manhole shaft shown in Dwg D1 is now measured from lip of channel.

Allowable Roadway Flows

Charts R1 and R2 plot allowable approach flows in accordance with Qudm sections 5.8 and 5.9. The plots are for mountable kerb but nearly enough substitute for barrier kerb types as well.

Design Charts

Charts are provided for the cover and each grate for each of the four inlet lengths described for cross falls of 2.5% and 3.0% and grades 0.25% to 16%. A table of factors provides solutions for other crossfalls. Sag inlet charts may be used for all kerb and channel types, all grate types and the cover.

Blockage

For design, laboratory captures are reduced by a blockage factor to compensate for diminished capture in the field, arising from lower construction tolerances and debris accumulation. For Mannflow type inlets, subjected to 10 litres of typical pollutant mix at full scale, captures for flows up to 250L/s on grade, showed no reduction at 1% and a 5% reduction at 4% and 12% grades. Debris cleared almost entirely as flows were reduced.

Maxflow grates with 80x110 streamlined openings are very blockage resistant. For system design apply Qudm -1992 blockage factors, to chart captures, as follows:

- Inlet on grade – with grate 0.9 – with cover 0.8
- Inlet in sag – with grate 1.0 – with cover 0.8

Chamber Water Level

To meet the test conditions design chamber water levels, measured from the D/S channel invert, must not exceed:

Road grade %	0TP, 1TP and 2PT	3PT
0.25% - 8%	150mm	150mm
>8% to 16%	150mm	300mm

Child Safety

Drainway Plus kerb openings are limited to 100mm. This is a desirable maximum opening to guard against small children being washed into the inlet.

Pedestrian Safety

The cover has previously been preferred to a vaned grate for pedestrian precincts although grates, having better capture, are more cost efficient. The pedestrian friendly Mannflow grate with flat surface and slot width <17mm now provides a cost efficient alternative to covers in most cases.

Hydraulic Efficiency

The Maxflow grate's capture efficiency makes it the preferred choice outside of pedestrian precincts.

Charts

Design charts provided are:

No	Kerb and Channel Type	Cross-fall
----	-----------------------	------------

Maxflow Grate

D1	Mountable/Rolltop	3.0%
D2	Mountable/Rolltop	2.5%

Mannflow Grate

D3	Mountable/Rolltop	3.0%
D4	Mountable/Rolltop	2.5%

Cover

D5	Mountable/Rolltop	3.0%
D6	Mountable/Rolltop	2.5%

Sag

D7	All kerb types	2 - 4%
----	----------------	--------

Conversion Factors

D8	All kerb types	2 - 4%
----	----------------	--------

DRAINWAY PLUS

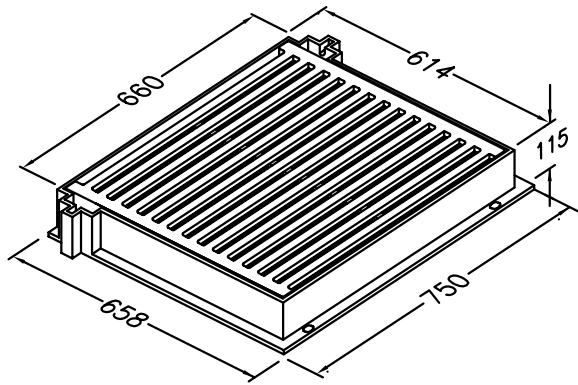

MANNFLOW GRATE

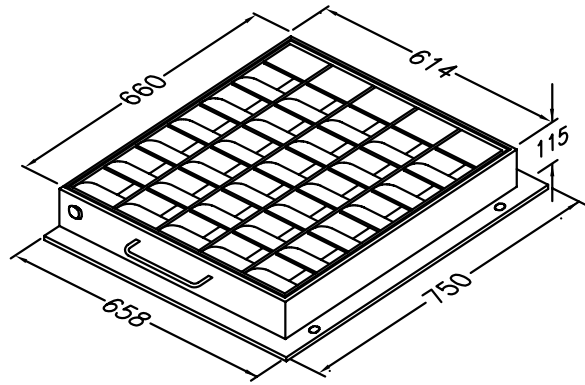

MAXFLOW GRATE

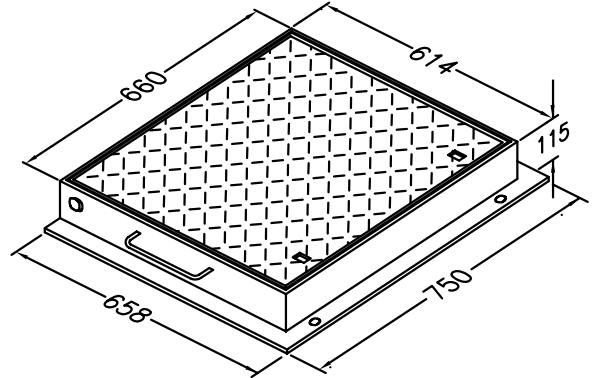

DRAINCOVER

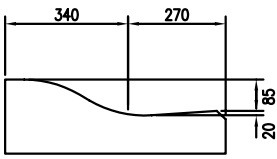

ROLL TOP

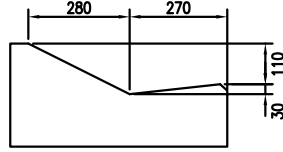

REGULAR

MOUNTABLE KERB TYPES

(BOTH TYPES HAVE SIMILAR CAPTURE CHARACTERISTICS WITH DRAINWAY)

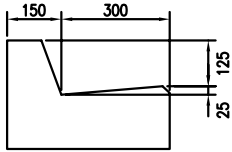

BK300

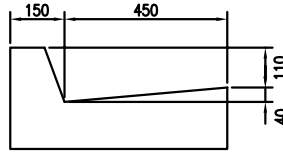

BK450

BARRIER KERB TYPES

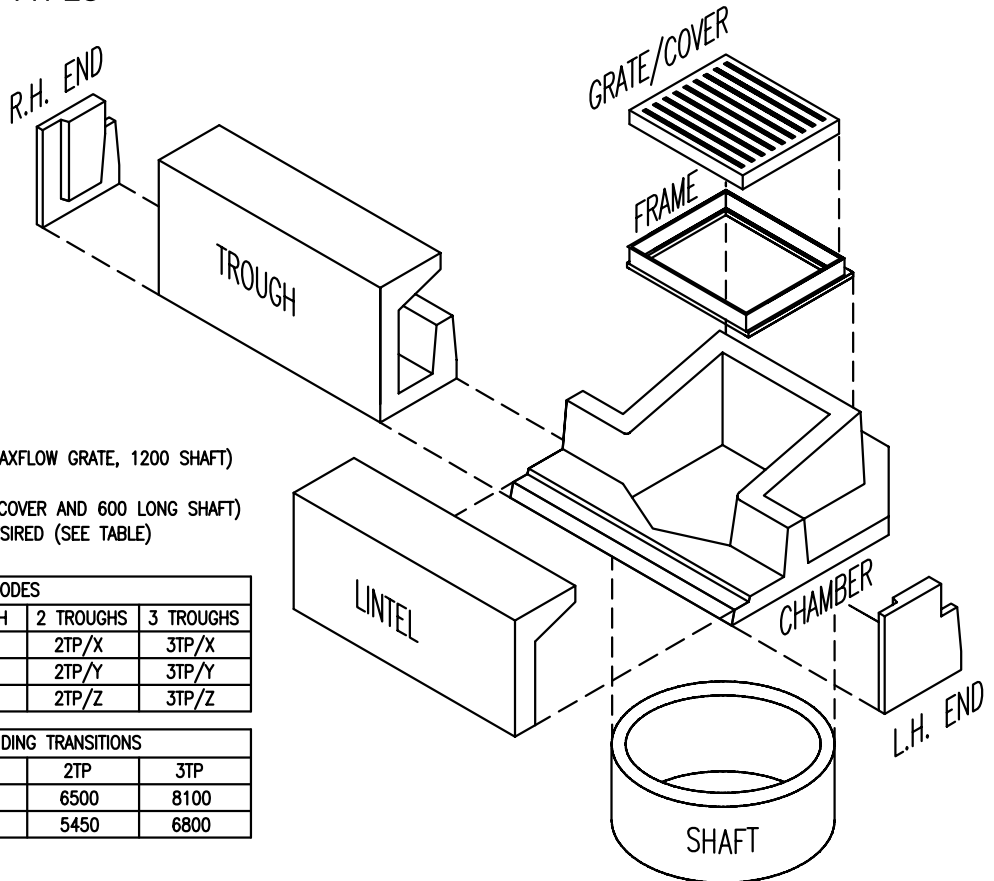

SPECIFICATION CODES:

- DRAINWAY PLUS - P
- MAXFLOW GRATE - X
- MANNFLOW GRATE - Y
- DRAINCOVER - Z
- TROUGH - NUMBER OF - 0T, 1T, 2T, 3T
- DRAINWAY PLUS LINTEL AND CHAMBER - P
- SHAFT LENGTH S0, S4.5, S6, S9, S12
- TYPICAL UNIT WITH GRATE - 1TP/X/S12
- (1 TROUGH, D'WAY PLUS LINTEL/CHAMBER, MAXFLOW GRATE, 1200 SHAFT)
- TYPICAL UNIT WITH COVER - 2TP/Z/S6
- (2 TROUGHS, D'WAY PLUS LINTEL/CHAMBER, COVER AND 600 LONG SHAFT)
- OMIT SHAFT SPECIFICATION FROM CODE IF DESIRED (SEE TABLE)

TYPICAL INLET CODES				
COVER/GRATE	0 TROUGH	1 TROUGH	2 TROUGHS	3 TROUGHS
MAXFLOW GRATE	0TP/X	1TP/X	2TP/X	3TP/X
MANNFLOW GRATE	0TP/Y	1TP/Y	2TP/Y	3TP/Y
DRAINCOVER	0TP/Z	1TP/Z	2TP/Z	3TP/Z

OVERALL INLET LENGTH INCLUDING TRANSITIONS				
	0TP	1TP	2TP	3TP
INLETS ON GRADE	3300	4900	6500	8100
INLETS IN SAG	2750	4100	5450	6800

ARRANGEMENT OF PRECAST UNITS

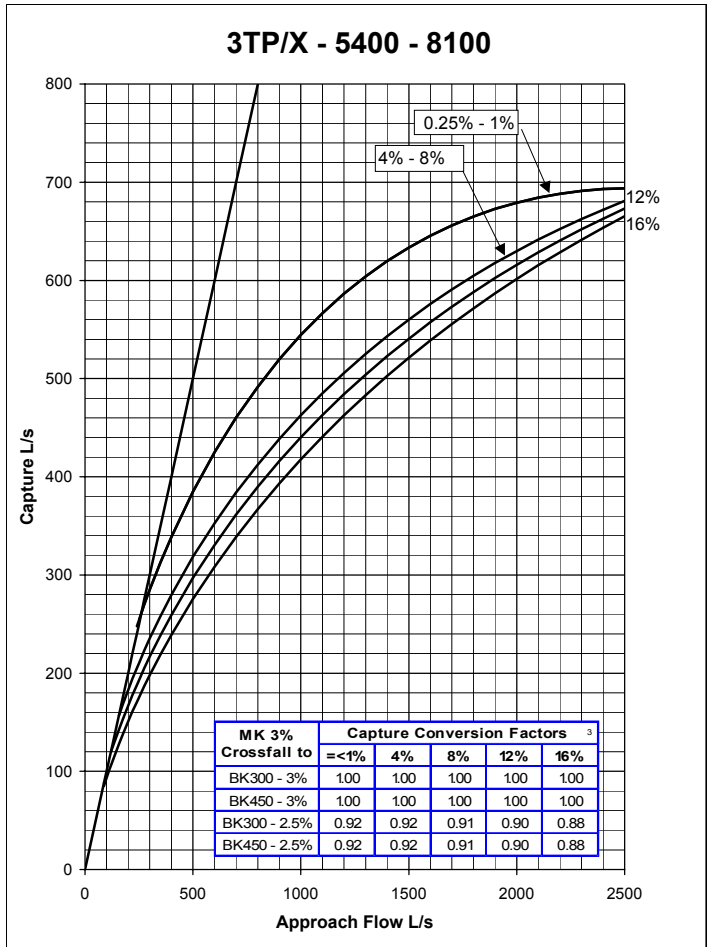
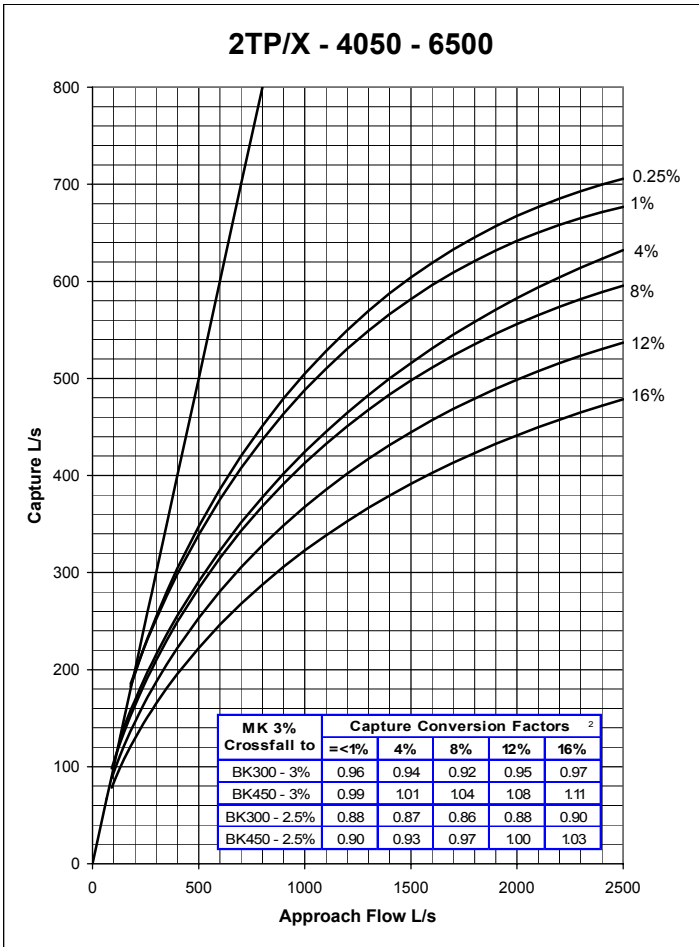
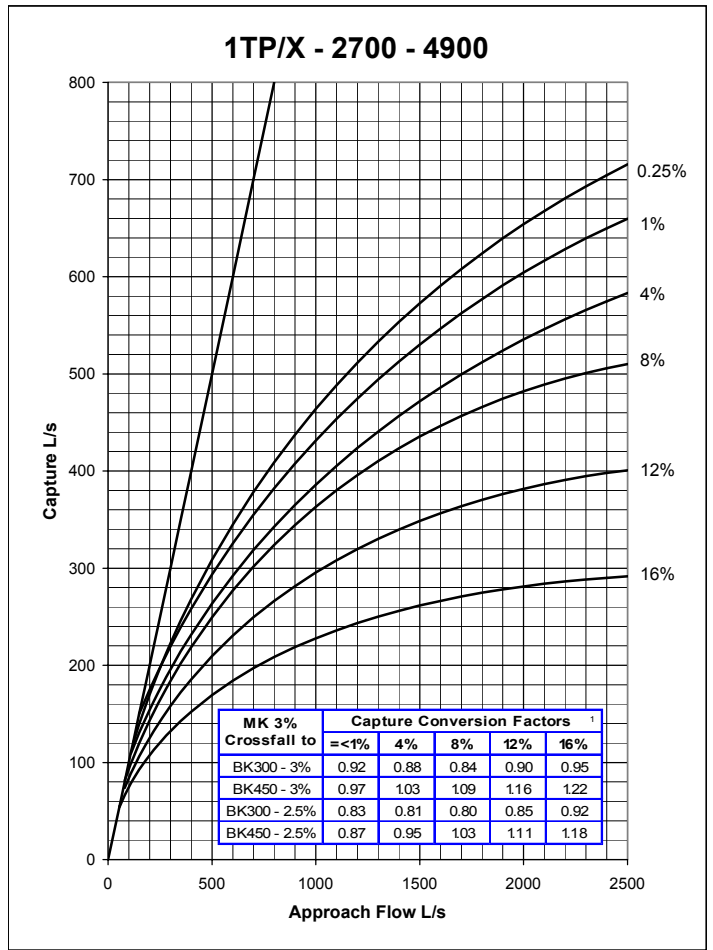
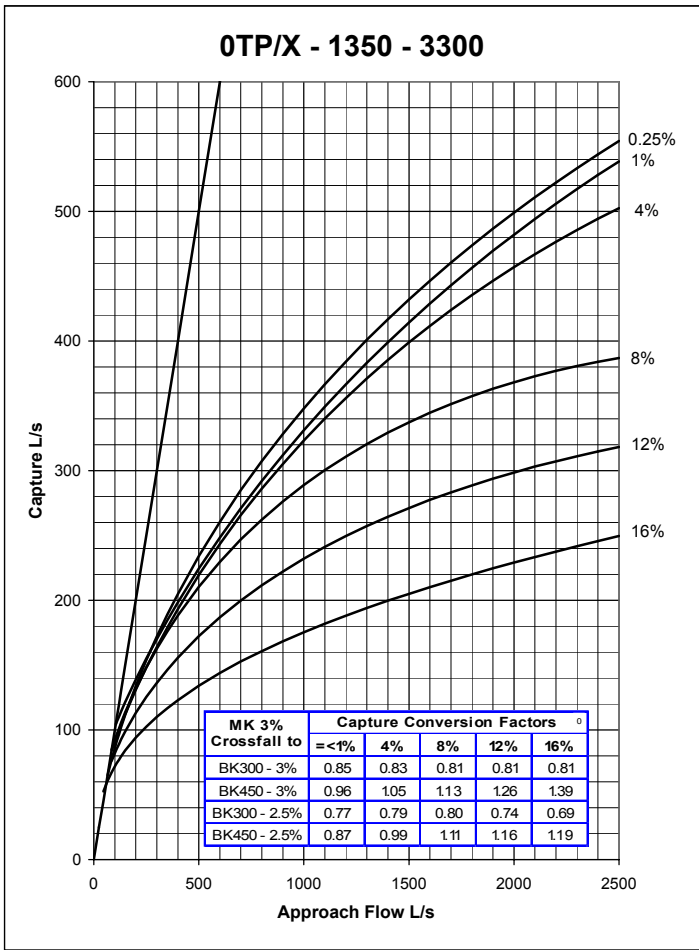

DRAINWAY PLUS MAXFLOW GRATE MOUNTABLE KERB - 3% CROSSFALL

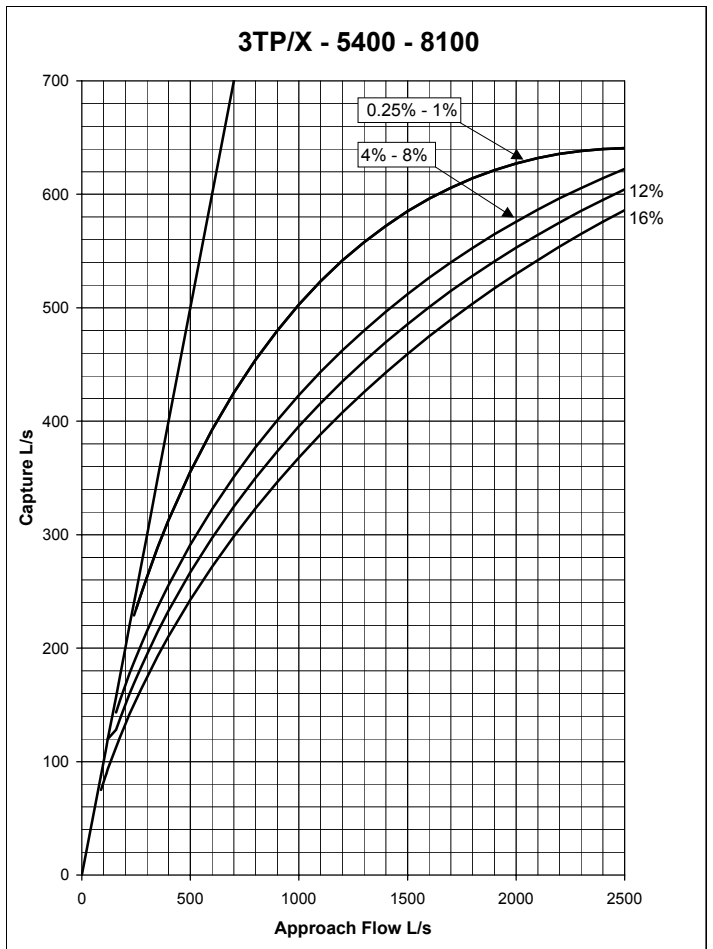
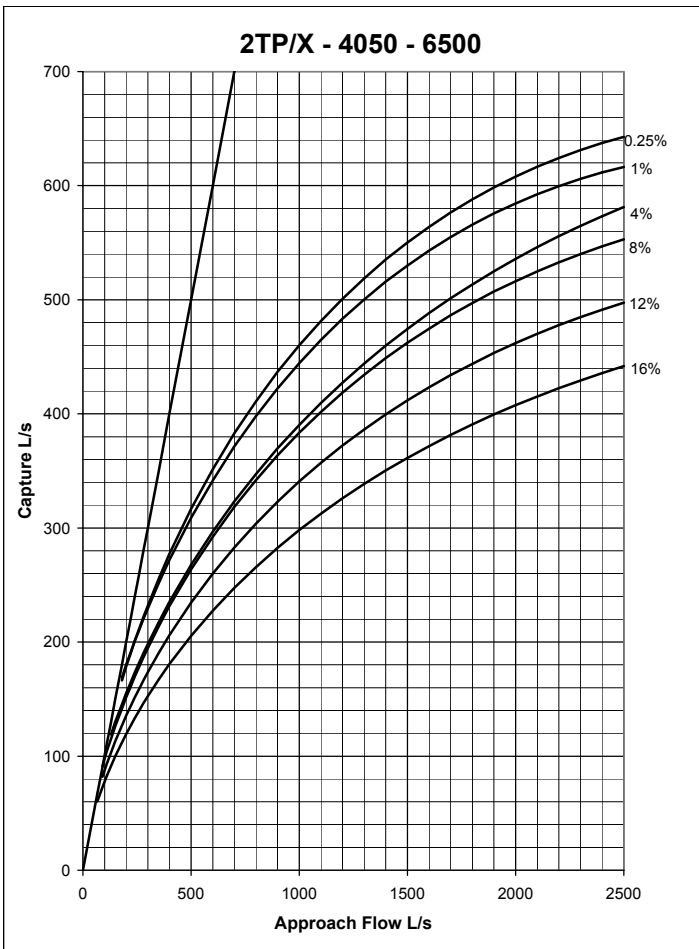
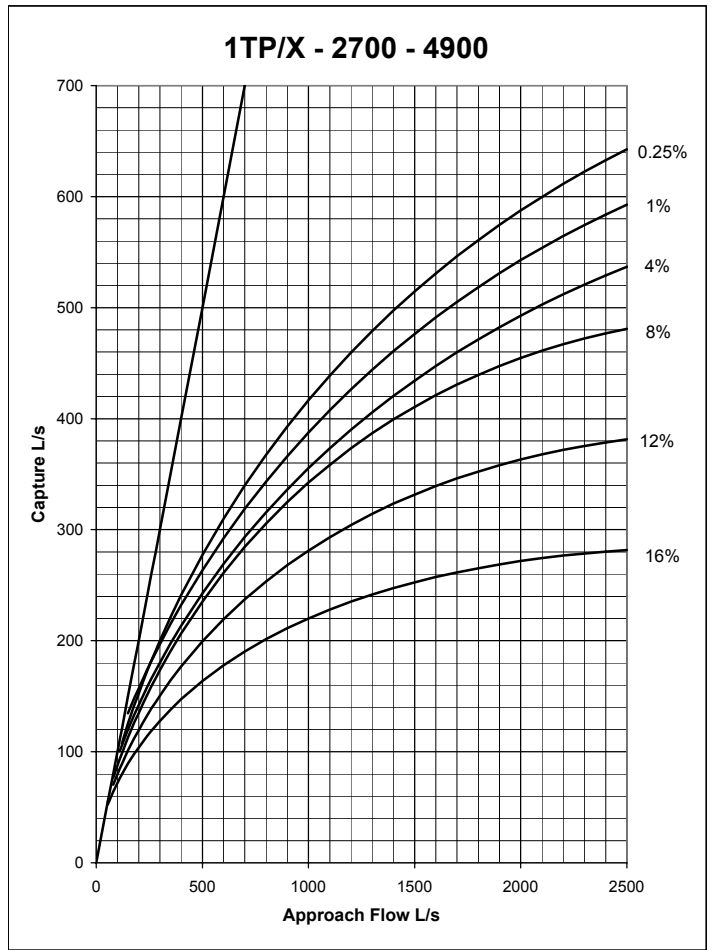
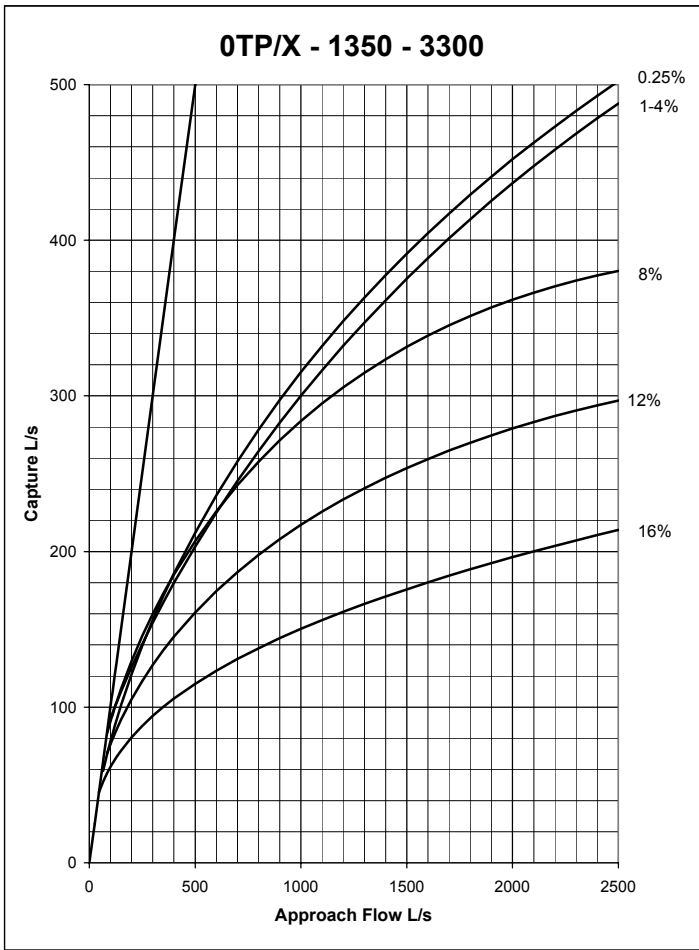

**DRAINWAY PLUS
MAXFLOW GRATE
MOUNTABLE KERB - 2.5% CROSSFALL**

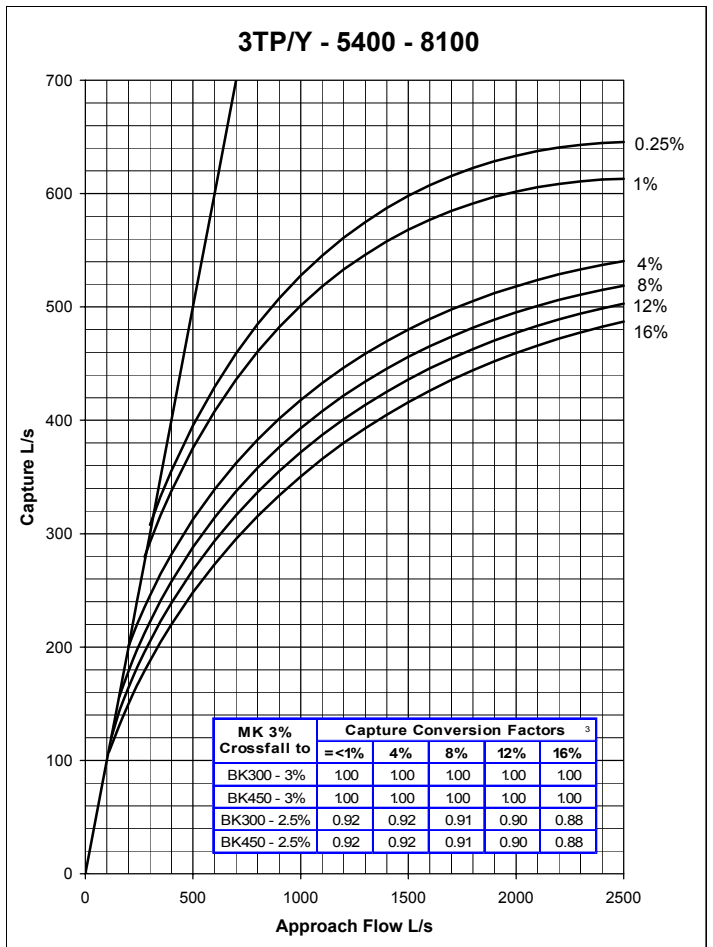
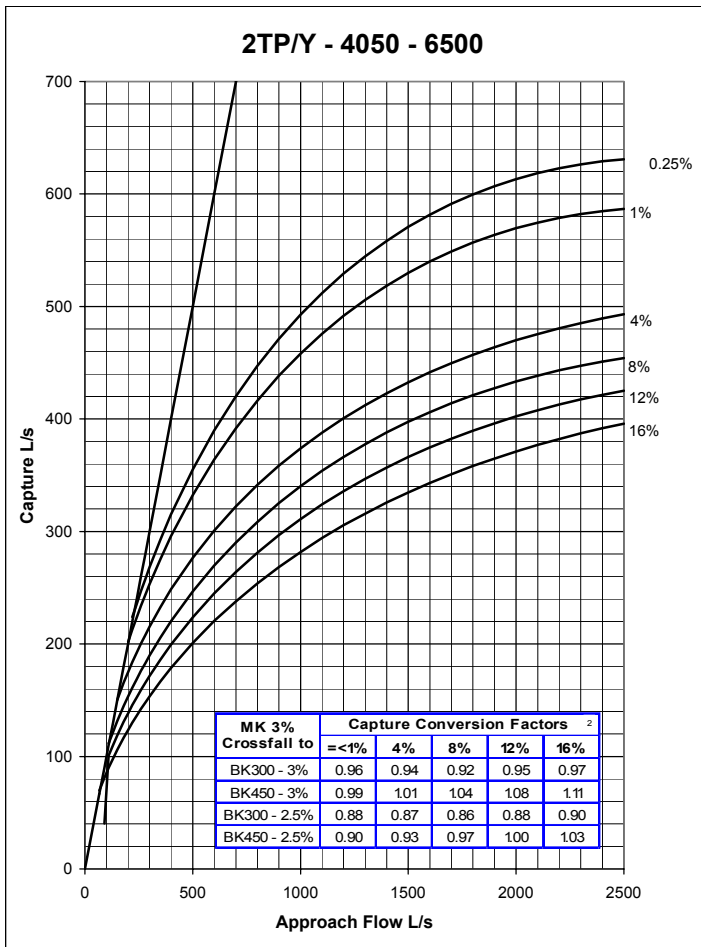
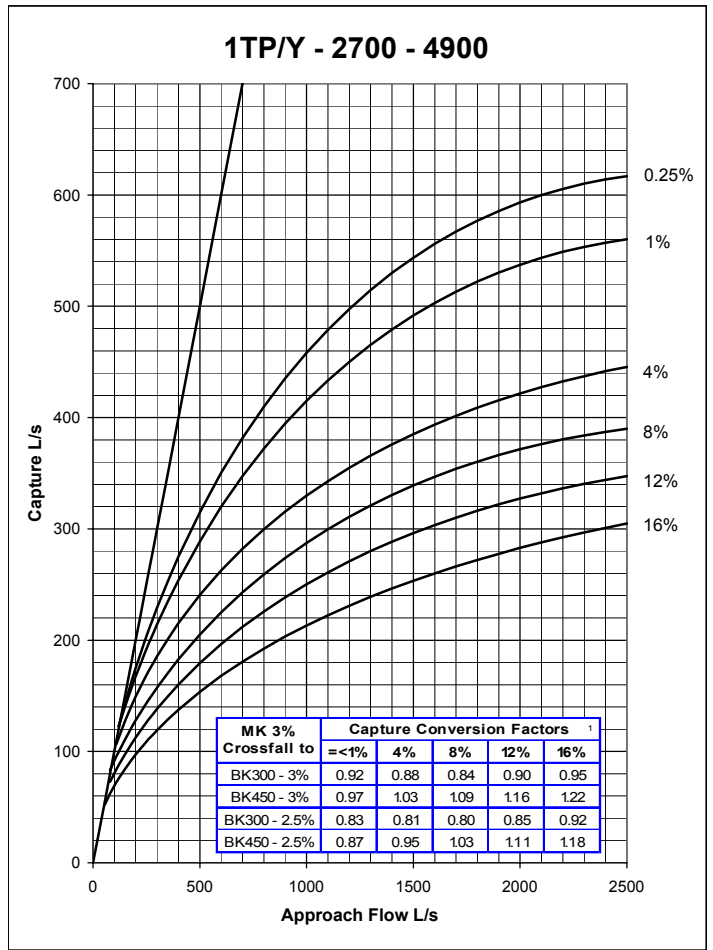
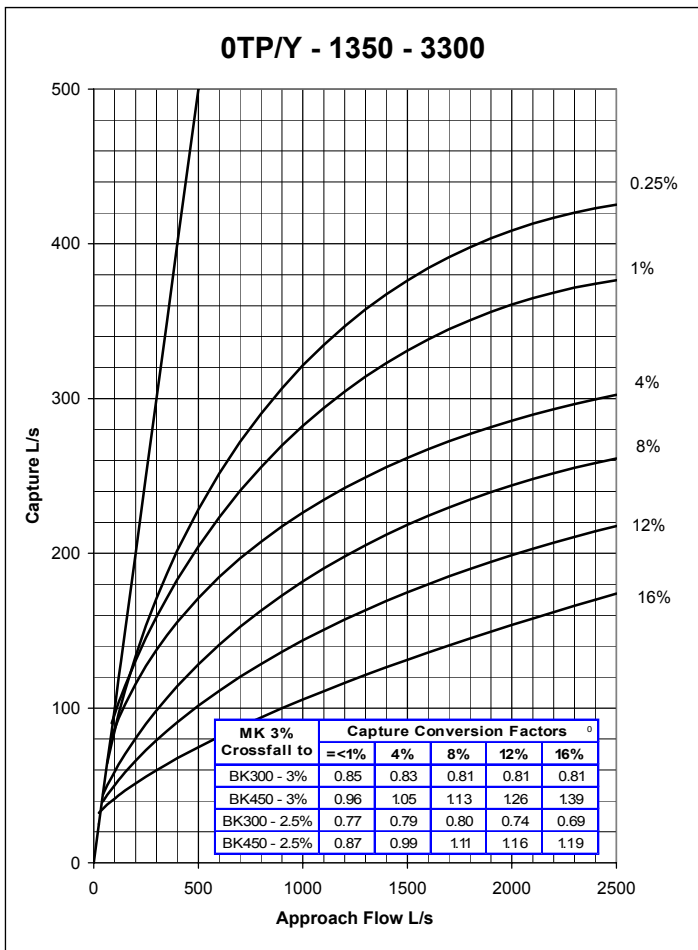

DRAINWAY PLUS MANNFLOW GRATE MOUNTABLE KERB - 3% CROSSFALL

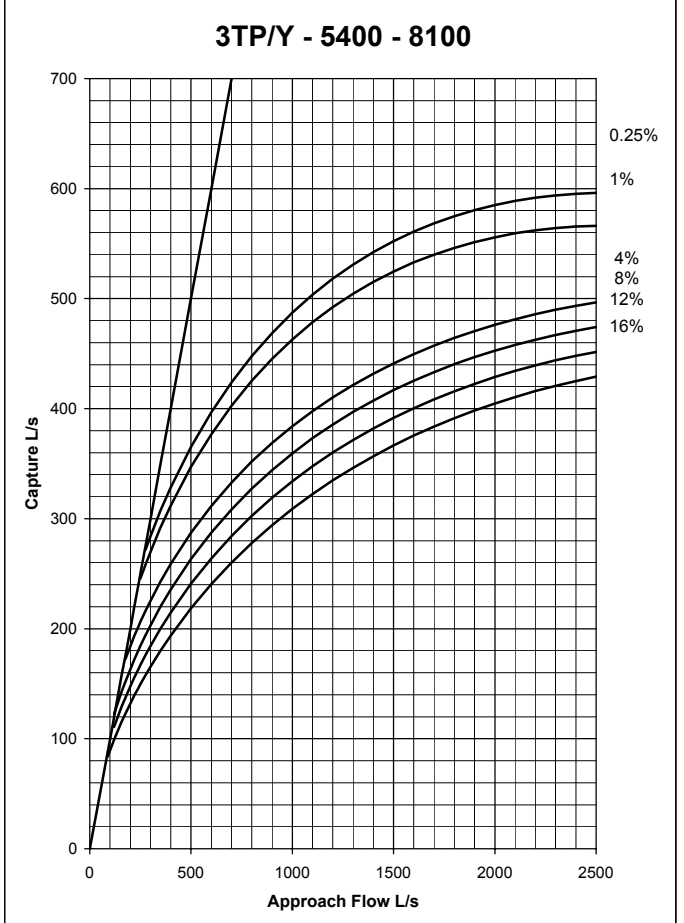
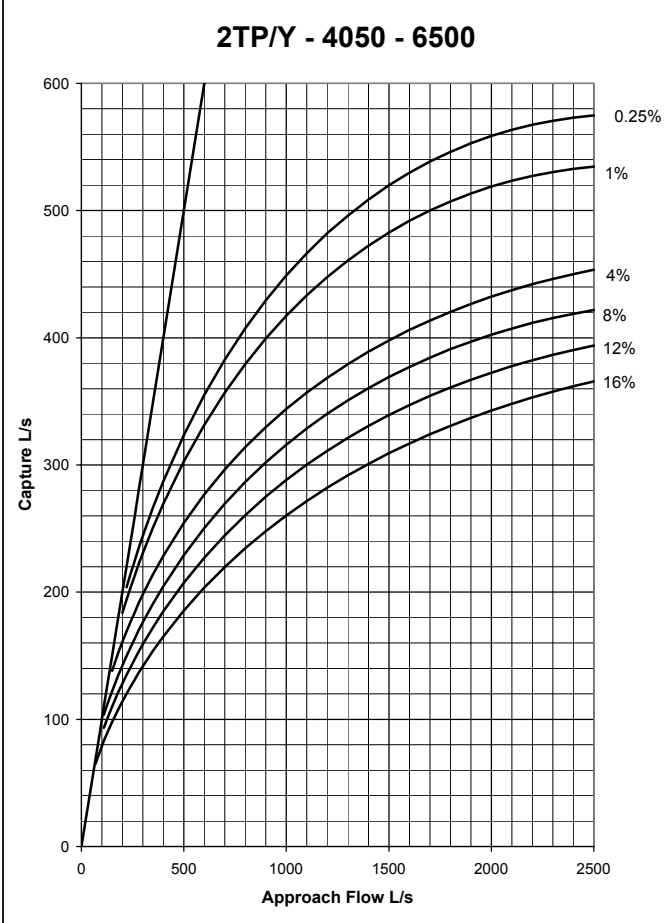
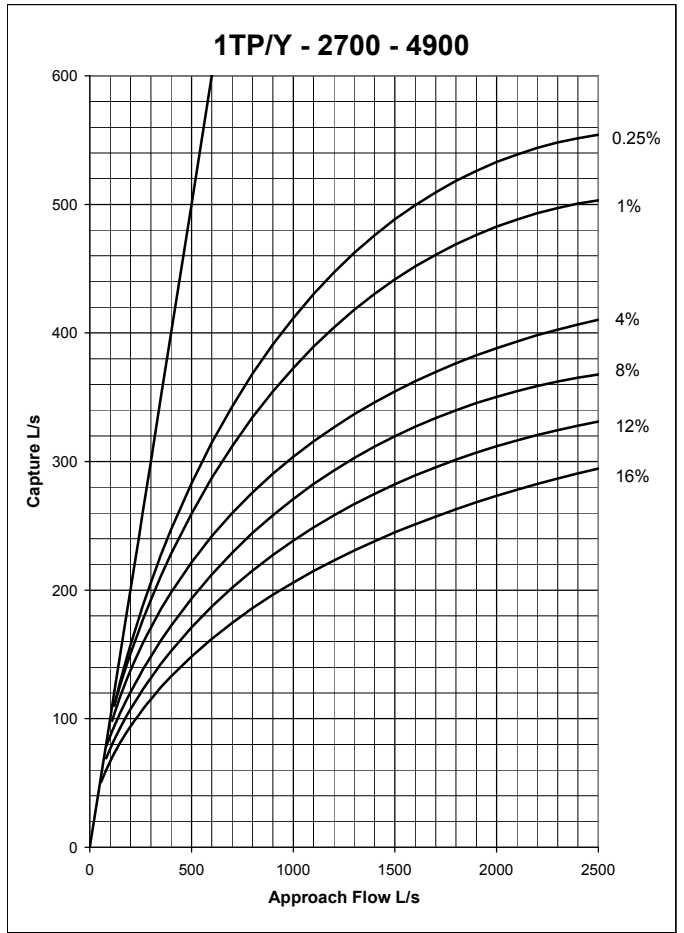
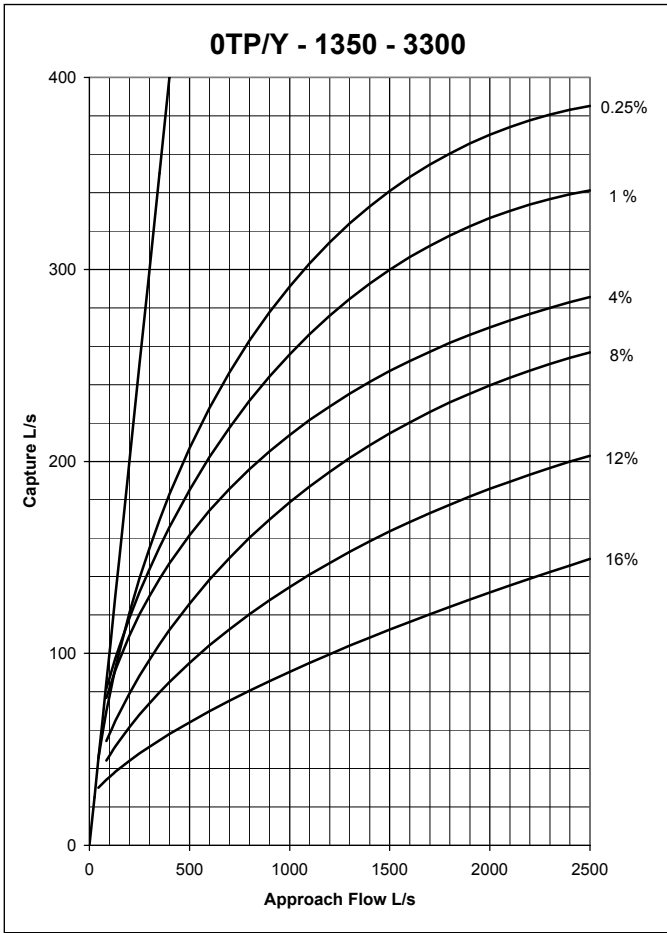

**DRAINWAY PLUS
MANNFLOW GRATE
MOUNTABLE KERB - 2.5% CROSSFALL**

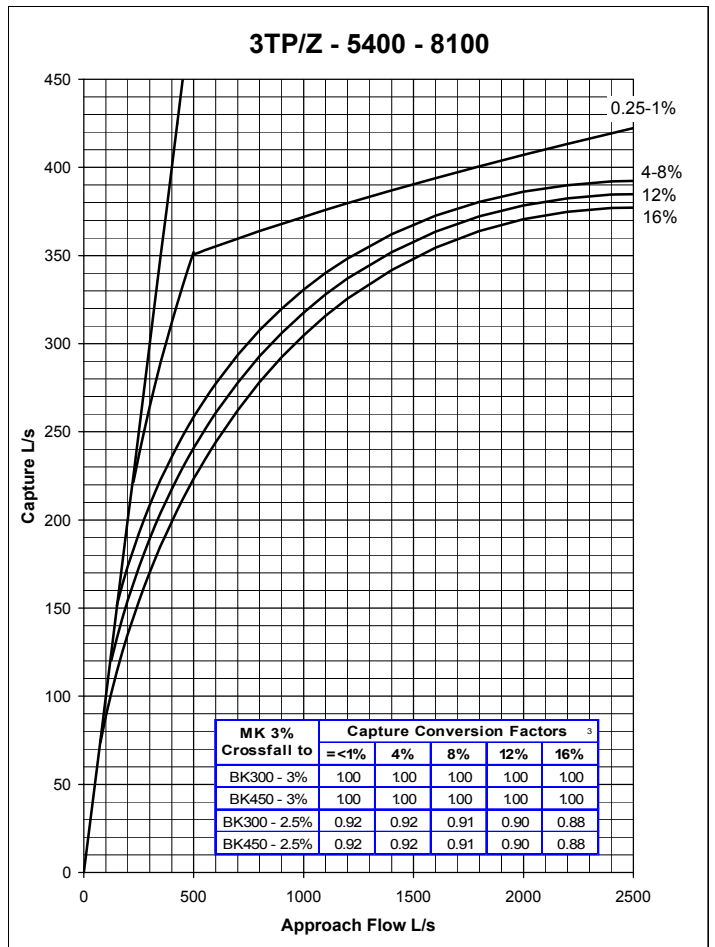
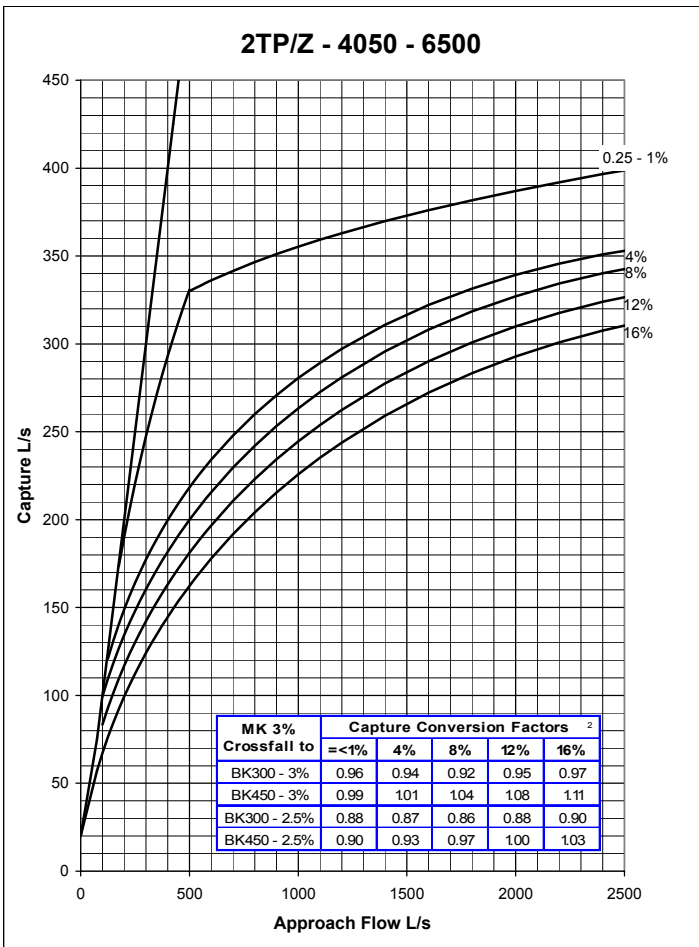
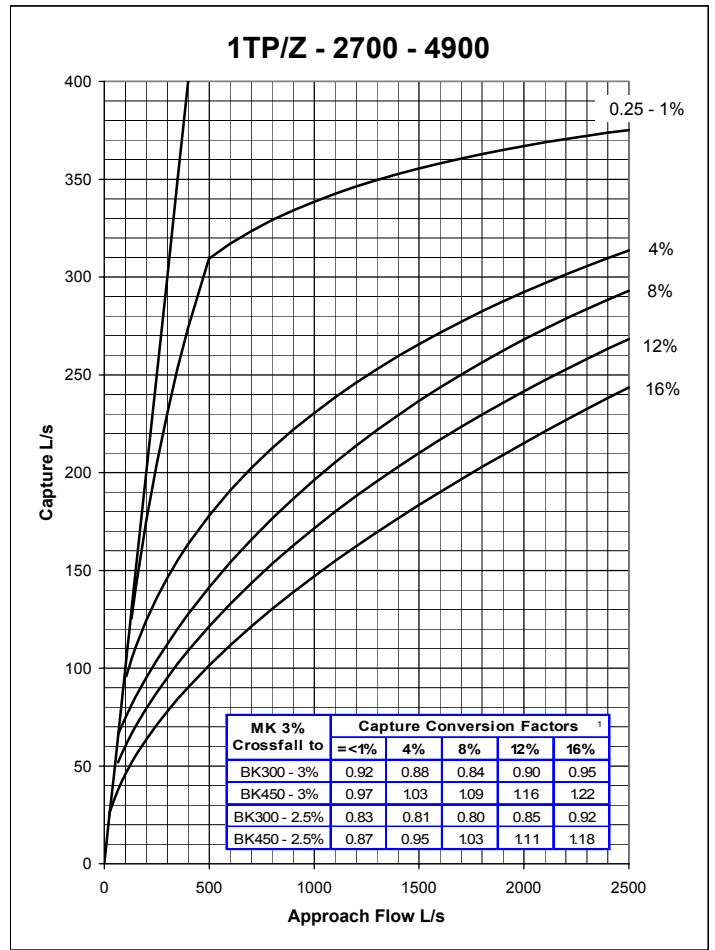
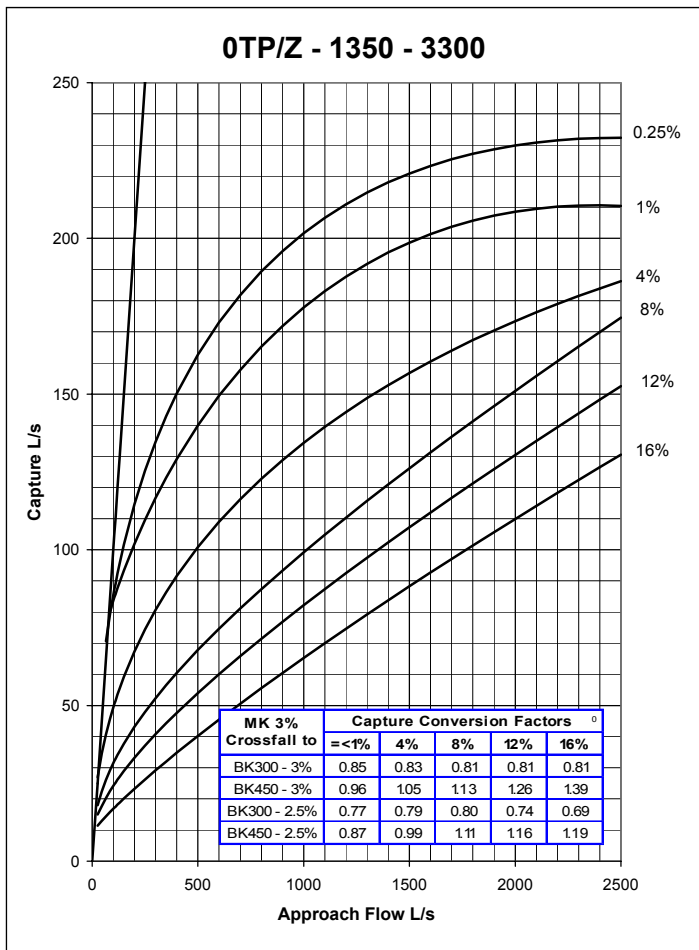

DRAINWAY PLUS DRAINCOVER MOUNTABLE KERB - 3% CROSSFALL

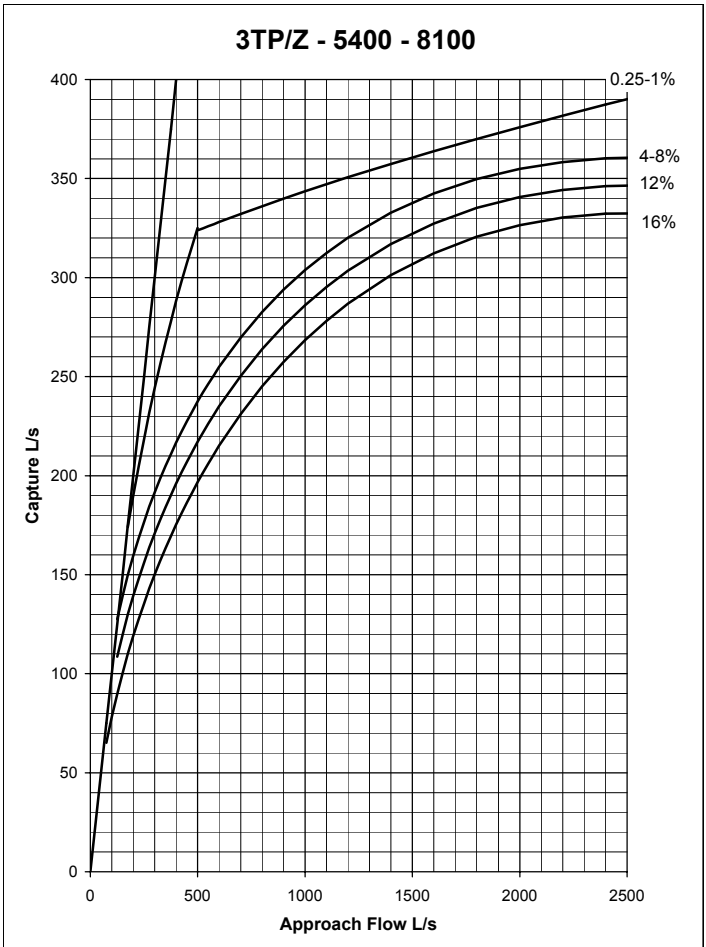
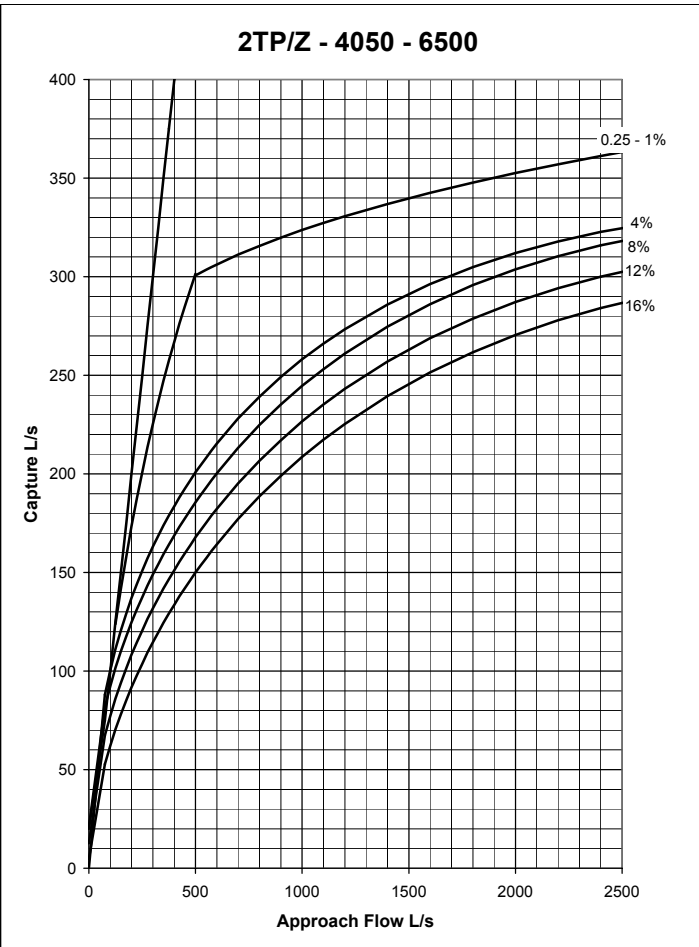
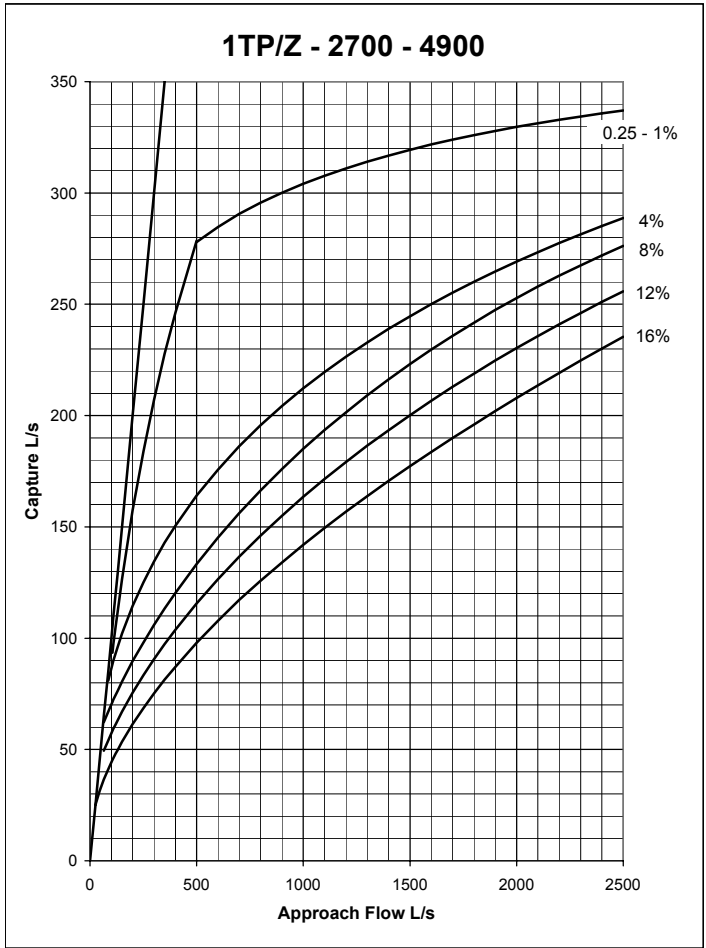
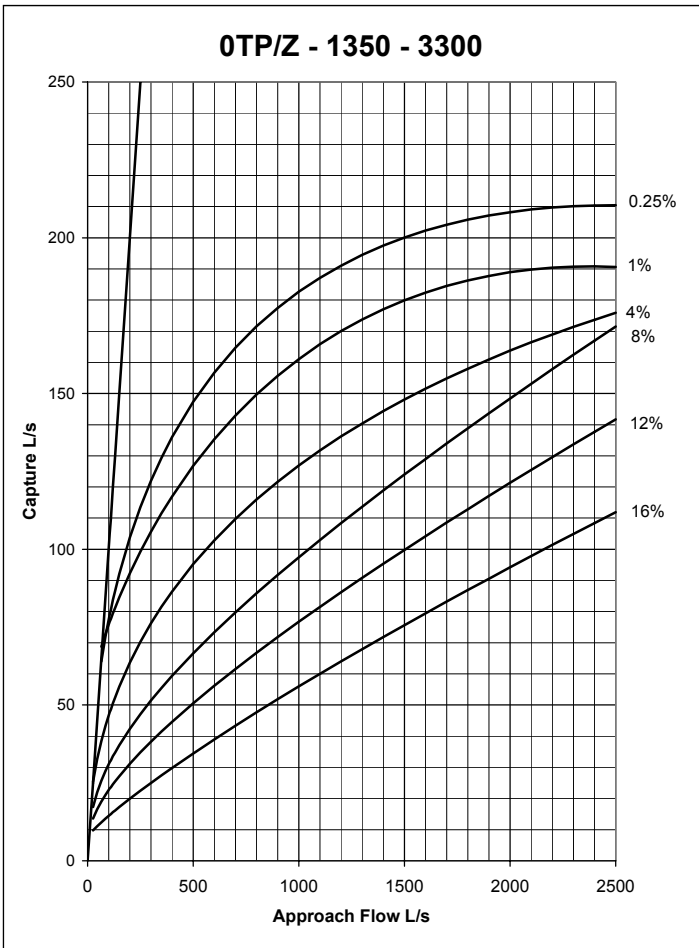

**DRAINWAY PLUS
DRAINCOVER
MOUNTABLE KERB - 2.5% CROSSFALL**

SAG CAPTURE V FLOW DEPTH

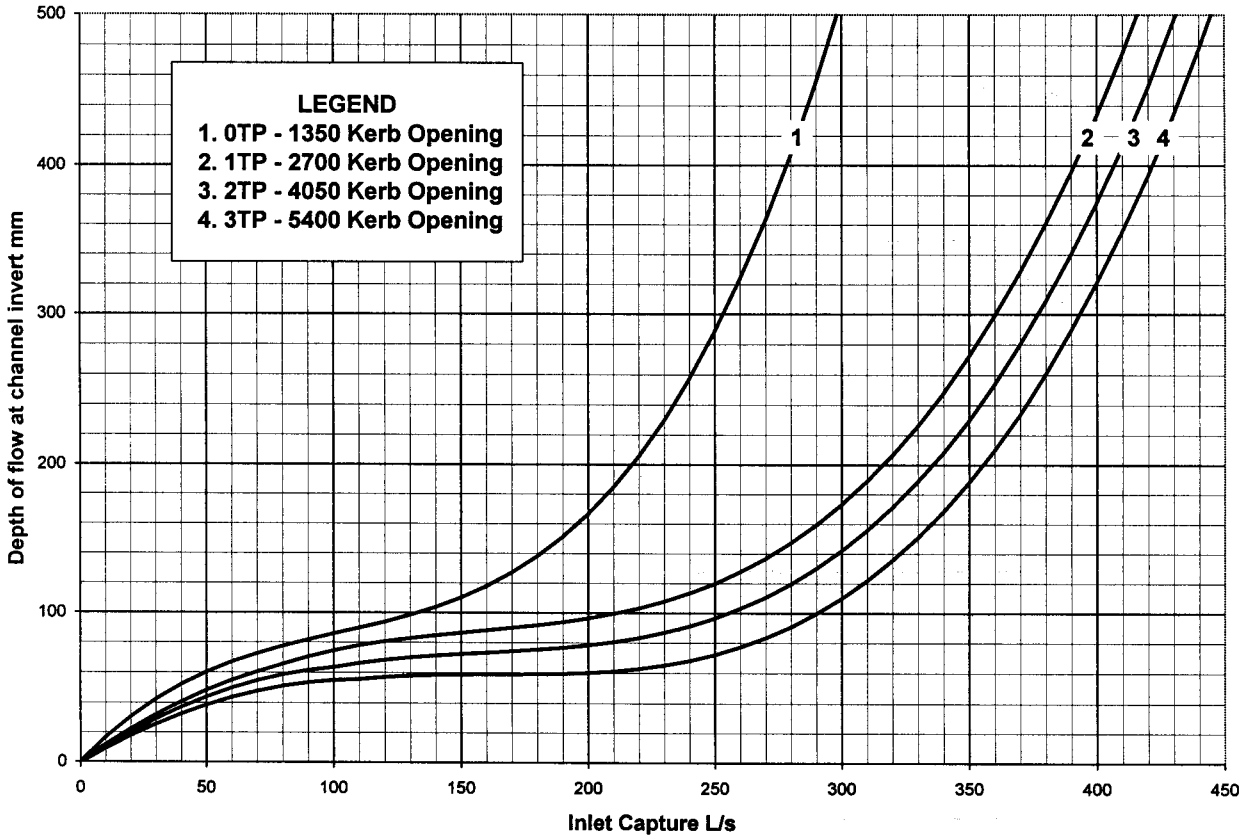

MINIMUM DESIGN FREEBOARD		
ROAD GRADE %	0TP, 1TP, 2PT	3PT
SAG - 8%	=>150mm	=>150mm
8% - 16%	=>150mm	=>300mm

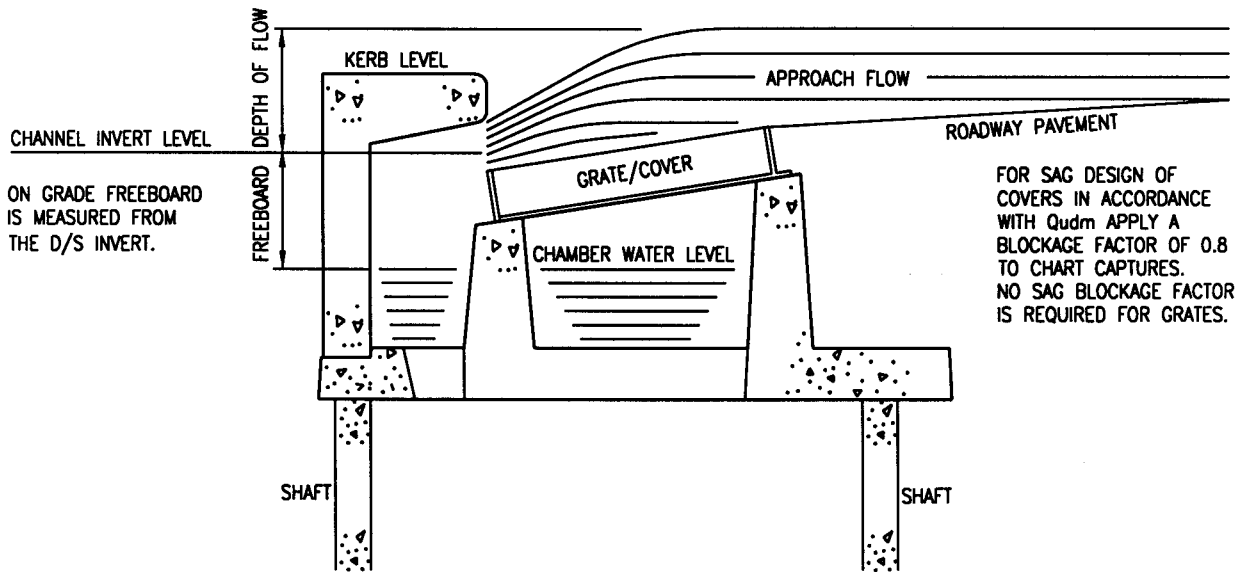

CHAMBER CROSS SECTION

DRAINWAY PLUS SAG CAPTURE - ALL GRATES AND COVER ALL KERB TYPES AND CROSSFALLS

Mountable M1 and Rolltop M3 Kerb and Channel - At Pavement Crossfalls 2% to 4%

TABLE D1

Inlet	Factor to be applied to Mountable Kerb 3.0% Crossfall chart captures																								
	2%					2.5%					3%					3.3%					4%				
X-fall	=<1%	4%	8%	12%	16%	=<1%	4%	8%	12%	16%	=<1%	4%	8%	12%	16%	=<1%	4%	8%	12%	16%	=<1%	4%	8%	12%	16%
Grade	0.86	0.85	0.83	0.82	0.80	0.91	0.94	0.98	0.92	0.86	1.00	1.00	1.00	1.00	1.00	1.03	1.02	1.01	1.01	1.02	1.09	1.06	1.03	1.04	1.05
0TP	0.86	0.85	0.83	0.82	0.80	0.91	0.94	0.98	0.92	0.86	1.00	1.00	1.00	1.00	1.00	1.03	1.02	1.01	1.01	1.02	1.09	1.06	1.03	1.04	1.05
ITP	0.88	0.88	0.87	0.86	0.85	0.90	0.92	0.94	0.95	0.97	1.00	1.00	1.00	1.00	1.00	1.01	1.01	1.02	1.01	1.00	1.04	1.05	1.06	1.03	1.01
2TP	0.88	0.87	0.86	0.84	0.82	0.91	0.92	0.93	0.93	0.92	1.00	1.00	1.00	1.00	1.00	1.01	1.01	1.01	1.01	1.00	1.02	1.03	1.04	1.02	1.00
3TP	0.89	0.87	0.85	0.82	0.78	0.92	0.92	0.91	0.90	0.88	1.00	1.00	1.00	1.00	1.00	1.00	1.00	1.00	1.00	1.00	1.01	1.01	1.02	1.00	0.99
Average	0.85					0.92					1.00					1.01					1.03				

Barrier Kerb B1 with 300 Channel - At Pavement Crossfalls 2% to 4%

TABLE D2

Inlet	Factor to be applied to Mountable Kerb 3.0% Crossfall chart captures																								
	2%					2.5%					3%					3.3%					4%				
Grade	=<1%	4%	8%	12%	16%	=<1%	4%	8%	12%	16%	=<1%	4%	8%	12%	16%	=<1%	4%	8%	12%	16%	=<1%	4%	8%	12%	16%
0TP	0.73	0.70	0.67	0.66	0.65	0.77	0.79	0.80	0.74	0.69	0.85	0.83	0.81	0.81	0.81	0.88	0.85	0.82	0.82	0.82	0.93	0.88	0.84	0.84	0.85
ITP	0.81	0.77	0.73	0.77	0.81	0.83	0.81	0.80	0.85	0.92	0.92	0.88	0.84	0.90	0.95	0.93	0.89	0.86	0.90	0.95	0.96	0.92	0.89	0.92	0.95
2TP	0.85	0.82	0.79	0.79	0.79	0.88	0.87	0.86	0.88	0.90	0.96	0.94	0.92	0.95	0.97	0.97	0.95	0.93	0.95	0.97	0.98	0.97	0.95	0.96	0.97
3TP	0.89	0.87	0.85	0.82	0.78	0.92	0.92	0.91	0.90	0.88	1.00	1.00	1.00	1.00	1.00	1.00	1.00	1.00	1.00	1.00	1.01	1.01	1.02	1.00	0.99
Average	0.78					0.85					0.92					0.93					0.94				

Barrier Kerb B1 with 450 Channel - At Pavement Crossfalls 2% to 4%

TABLE D3

Inlet	Factor to be applied to Mountable Kerb 3.0% Crossfall chart captures																								
	2%					2.5%					3%					3.3%					4%				
Grade	=<1%	4%	8%	12%	16%	=<1%	4%	8%	12%	16%	=<1%	4%	8%	12%	16%	=<1%	4%	8%	12%	16%	=<1%	4%	8%	12%	16%
0TP	0.82	0.88	0.94	1.03	1.11	0.87	0.99	1.11	1.16	1.19	0.96	1.05	1.13	1.26	1.39	0.98	1.06	1.15	1.28	1.41	1.04	1.11	1.17	1.32	1.46
ITP	0.86	0.90	0.95	1.00	1.04	0.87	0.95	1.03	1.10	1.18	0.97	1.03	1.09	1.16	1.22	0.98	1.04	1.11	1.17	1.22	1.01	1.08	1.15	1.19	1.23
2TP	0.87	0.89	0.90	0.90	0.91	0.90	0.93	0.97	1.00	1.03	0.99	1.01	1.04	1.08	1.11	0.99	1.02	1.06	1.08	1.11	1.01	1.04	1.08	1.10	1.11
3TP	0.89	0.87	0.85	0.82	0.78	0.92	0.92	0.91	0.90	0.88	1.00	1.00	1.00	1.00	1.00	1.00	1.00	1.00	1.00	1.00	1.01	1.01	1.02	1.00	0.99
Average	0.91					0.99					1.07					1.08					1.11				

EXAMPLE:

What is the capture for 1000L/s approach flow to a Mannflow Grate with barrier kerb and 300 channel, 1% grade, 2% pavement crossfall for an inlet with one extension trough?

- (a) Mannflow Grate, mountable kerb, 3% crossfall is Chart D3, with 1 trough is 1TP/Y where capture for 1000L/s at 1% grade is 420L/s.
- (b) Conversion factor to Barrier Kerb 300 channel at 2% pavement crossfall from Chart D8 Table D2 - 1TP/1% = 0.81.
- (c) Capture = 420 x 0.81 = 340L/s.

Conversion Factors from mountable kerb 3% Xfall to BK300, BK450 at 3% and 2.5% X-falls, as set out above, are repeated for convenience in tables on Charts D1, D3 and D5. Separate charts for mountable kerb with 3.0% and 2.5% crossfall allow direct reading of captures, for the most common design configurations, without use of the tables. The "Average" factors may be used where it is considered the resulting loss of accuracy is tolerable.

**DRAINWAY PLUS
CONVERSION FACTORS
MOUNTABLE KERB - 3% CROSSFALL TO OTHER CONFIGURATIONS
CHART D8**

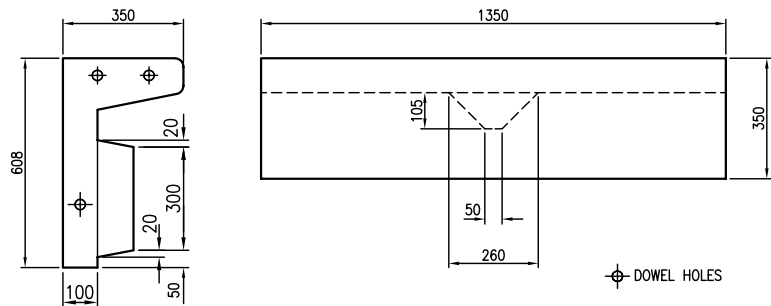

END ELEVATION

PLAN

LINTEL WITH DEFLECTOR

SCALE B

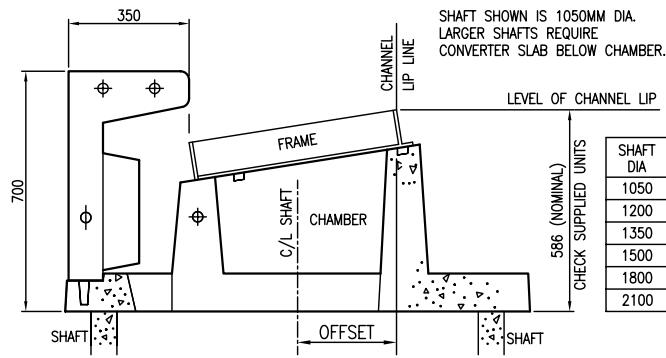

LINTEL, CHAMBER, FRAME AND SHAFT

SCALE B

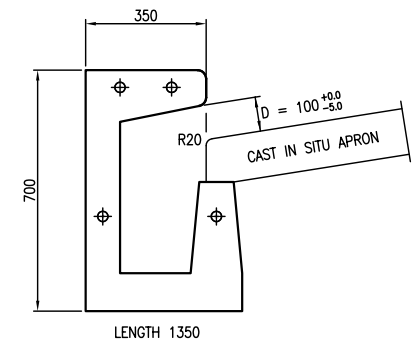

TROUGH AND APRON

SCALE B

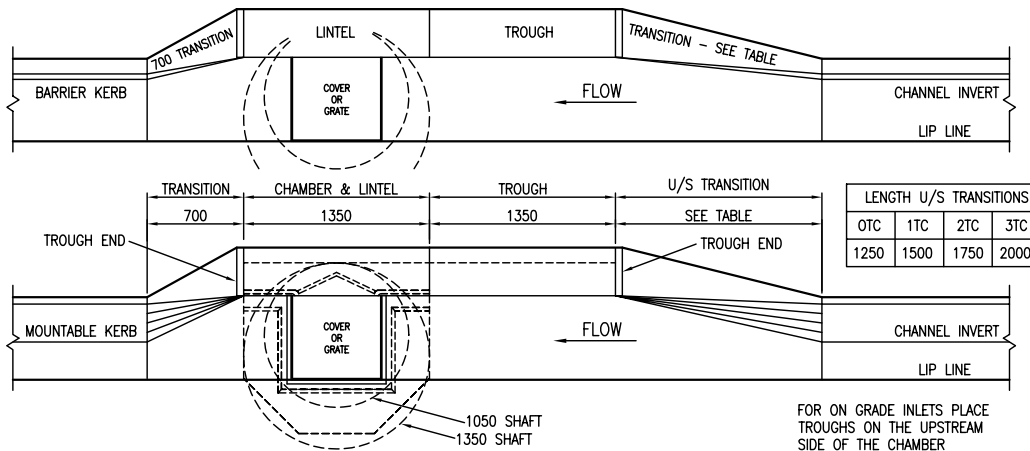

TYPICAL INLETS ON GRADE

SCALE A

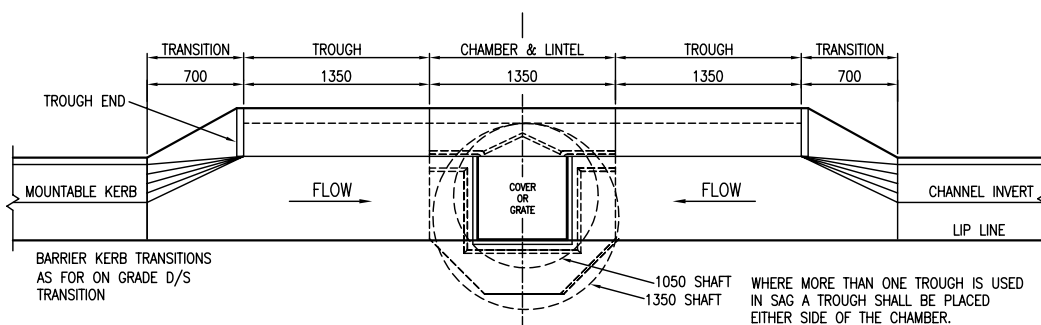

TYPICAL INLET IN SAG

SCALE A

DRAINWAY PLUS

SPECIAL FEATURES INCLUDE:

- DEFLECTOR FOR INCREASED HYDRAULIC PERFORMANCE.
- SEE ELEVATION AND PLAN.
- KERB OPENING INLET REDUCED TO 100mm.
- THIS ENSURES ADEQUATE CHILD SAFETY.
- 1250-2000mm U/S TRANSITIONS ON GRADE.
- THIS GIVES IMPROVED INLET CAPTURE.
- 700mm D/S TRANSITIONS REDUCE ON-GRADE INLET LENGTH.
- 700mm SAG TRANSITIONS REDUCE SAG INLET LENGTH.
- CHOICE OF MAXFLOW & MANNFLOW GRATES.
- DIMENSIONS RELATED TO CHANNEL LIP.
- THIS ALLOWS MORE LOGICAL CONSTRUCTION SETOUT.
- CALIBRATED TO 2500L/S FOR DESIGN ACCURACY AND ECONOMY.

SPECIFICATION CODES:

- DRAINWAY PLUS - P
- MAXFLOW GRATE - X
- MANNFLOW GRATE - Y
- MAXFLOW COVER - Z
- TROUGH - NUMBER OF - 0T, 1T, 2T, 3T
- DRAINWAY PLUS LINTEL AND CHAMBER - P
- SHAFT LENGTH S0, S4.5, S6, S9, S12
- TYPICAL UNIT WITH COVER - 2TP/Z/S6
- (2 TROUGHS, D'WAY PLUS LINTEL/CHAMBER, COVER AND 600 LONG SHAFT)
- TYPICAL UNIT WITH GRATE - 1TP/X/S12
- (1 TROUGH, D'WAY PLUS LINTEL/CHAMBER, MAXFLOW GRATE, 1200 SHAFT)
- OMIT SHAFT SPECIFICATION FROM CODE IF DESIRED (SEE TABLE)
- TO ENSURE INLETS ACHIEVE THEIR DESIGN FLOW CAPTURE, CONTRACTORS MUST NOT SUBSTITUTE ANOTHER GRATE FOR THAT SPECIFIED.

SUPPLY AND CONSTRUCTION NOTES:

1. PRECAST UNITS SHALL COMPLY WITH IPWEA DRAINWAY DRAWING D-0064.
2. PRECAST UNITS SHALL BE CONNECTED WITH DOWEL PINS.
3. MAXFLOW GRATES SHALL BE USED UNLESS OTHERWISE SPECIFIED.
4. THE SHAFT DIAMETER SHALL BE 1050mm UNLESS OTHERWISE SPECIFIED.
5. CONVERTER SLABS SHALL BE USED WITH SHAFTS LARGER THAN 1050mmØ.
6. UNLESS OTHERWISE DIRECTED, PIPES SHALL NOT PROTRUDE BEHIND THE KERB.
7. THE FOLLOWING SHALL CONFORM WITH PROJECT SPECIFICATION AND DRAWINGS.
 - A. DRAINAGE AND INLET LAYOUT.
 - B. HEIGHT OF THE SHAFT.
 - C. GRATE AND COVER TYPES.
 - D. KERB AND CHANNEL PROFILES.

COVER/GRATE	TYPICAL INLET CODES			
	0 TROUGH	1 TROUGH	2 TROUGHS	3 TROUGHS
MAXFLOW GRATE	0TP/X	1TP/X	2TP/X	3TP/X
MANNFLOW GRATE	0TP/Y	1TP/Y	2TP/Y	3TP/Y
DRAINCOVER	0TP/Z	1TP/Z	2TP/Z	3TP/Z

	OVERALL INLET LENGTH INCLUDING TRANSITIONS			
	0TP	1TP	2TP	3TP
INLETS ON GRADE	3300	4900	6500	8100
INLETS IN SAG	2750	4100	5450	6800

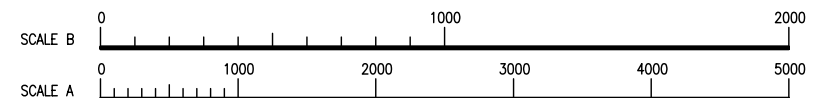

brochures\drawings\D1.dwg

NO	REVISIONS	DATE	INITS
C			
B			
A			
O	ORIGINAL ISSUE	1-10-03	PGB

DRAINWAY PLUS

DRAINWAY PLUS
CONSTRUCTION DETAILS

D1